

ONEWAY
BIOMEED

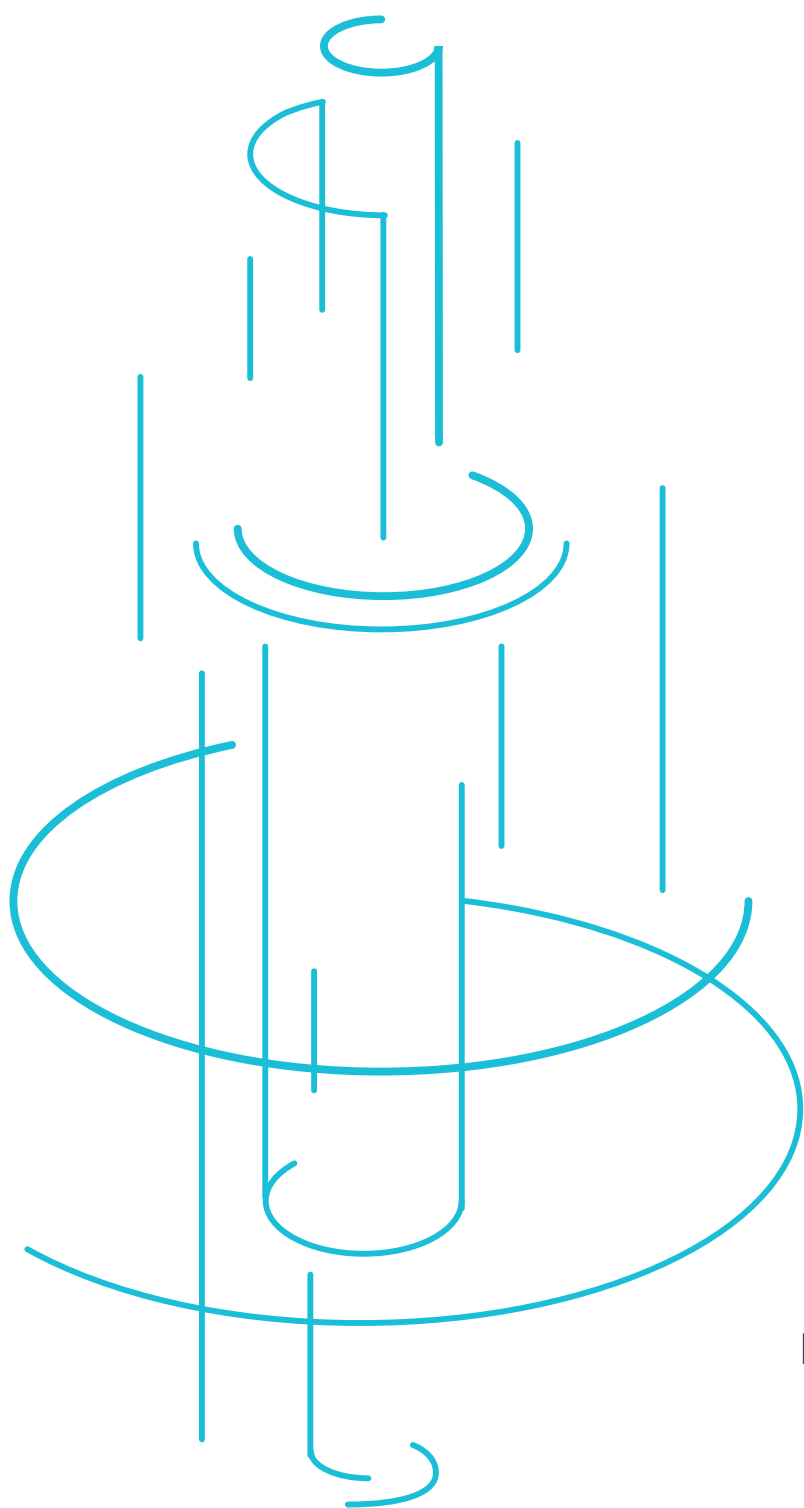

Two piece implants
DENTAL IMPLANT SYSTEM

GIH[®]

Symbols for Implant Properties and prosthetic solutions

Small Abutment Head



Large Abutment Head



Ball Abutment



Localicer® Abutment



Multi-Unit Abutment



Micro Thread



Bendable



Apical Wide Thread



For Screw-in Prosthetics



For Cemented Prosthetics

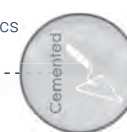

ONEWAY
BIOMED

THE ADVANTAGES

OF THE ENDOSSEOUS DENTAL IMPLANT SYSTEM GIH2

GIH2 implants with aggressive apical thread have a roughened endosseous surface. They feature an internal hex, an internal marginal taper and a US standard internal thread. As a result of many years of clinical observation of products, the design of the famous **GIH®** implants has been revised: The broadened apical thread is fully self-cutting. Thanks to the new apical thread portion, the implant is more stable even in weak bone and higher insertion torque can be reached.

The prescribed or recommended tightening torques for implants, abutments and screws can be found on our website:

www.implant.com/en/downloads



Clean and secure interface due to hex and conus

Can be anchored bicortical

Safe rotation protection through precision internal hexagon

Made of highly resistant titanium alloy

Smart instrument tray

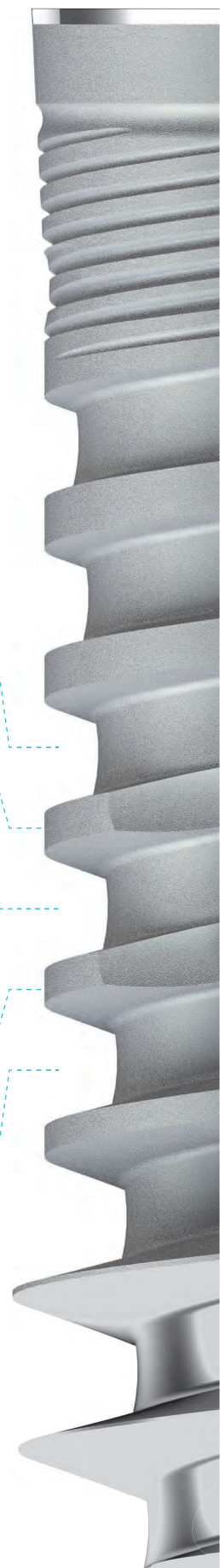

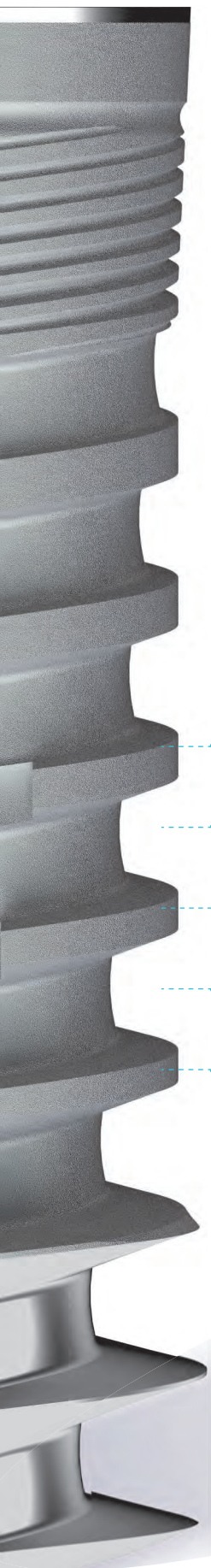

Wide range
of sizes

Enossal length

8 - 15 mm

Enossal Ø

3.3 - 5.5 mm

**No-Itis®
LASER:**

The new surface treatment for Dr. Ihde Dental AG implants is created with the latest generation of robotic tools for laser ablation. This new technology of high precision creates roughness in the implant through a mesh of hemispherical micrometric pores, with a defined, always identical size and shape and with a symmetrical distribution. The result is a more adequate topography, which provides the most suitable conditions for the osseointegration of the implant, but at the same time it is, and behaves like, a smooth surface at a micrometric (cellular) level. This means that while bone grows well on this surface, the adhesion of bacteria to the same surface is significantly reduced.

A smooth
surface that, in
contact with the bone,
is shaped like a
rough surface

Polished area for a
clean closing-off

No-Itis® LASER – THE NEW SURFACE GENERATION

The new surface treatment for Dr. Ihde Dental AG implants is created with the latest generation of robotic tools for laser ablation. This new technology of high precision creates roughness in the implant through a mesh of hemispherical micrometric pores, with a defined, always identical size and shape and with a symmetrical distribution.

The result is a more adequate topography, which provides the most suitable conditions for the osseointegration of the implant, but at the same time it is, and behaves like, a smooth surface at a micrometric (cellular) level. This means that while bone grows well on this surface, the adhesion of bacteria to the same surface is significantly reduced.

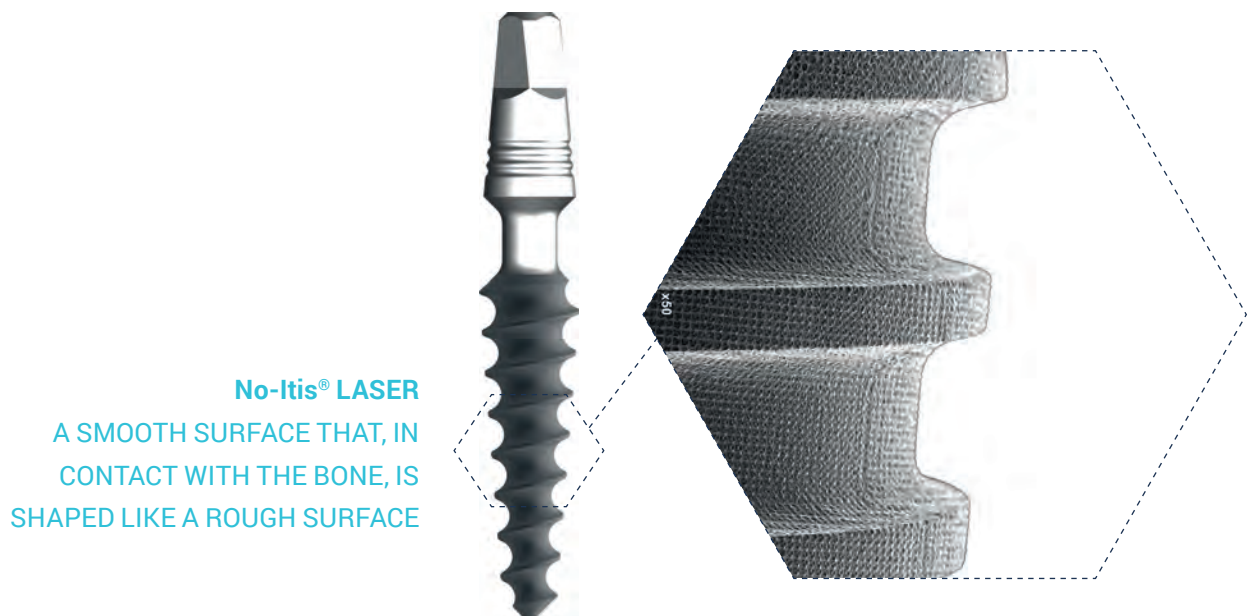

In the 1990s, rough surfaces on dental implants became increasingly popular – while the risk of bacterial adhesion was blissfully disregarded. This caused the appearance of a new disease, peri-implantitis, which severely compromises the survival of the implants in the long term and which, as a result, requires a renewed intervention on a dissatisfied patient, wasting time and increasing costs. Surfaces like that are not patient-friendly!

The use of the laser technology we developed allows us to create an exactly defined micromorphology on the treated surface, leaving no residue and without altering the properties or composition of the titanium alloy. This creates a mesh of very perfect cavities in terms of the (hemispherical) shape and its dimensions (of 20 to 30 μm), as well as their distance and distribution. The surface of these cavities as well as the retentions created by laser ablation are smooth as experienced by the bacteria, a characteristic that is assumed to improve the resistance of the implant against bacterial colonisation. This characteristic might also radically limit the incidence of peri-implantitis. In contact with the bone, however, the laser-ablated surface behaves like a rough surface. Rough implants (e.g., GCS®, GIH®) and smooth implants (e.g., GBC®, GCS®) therefore have the same recovery rate.

No-Itis® LASER
THE SURFACE THAT INCREASES SURVIVAL RATIOS

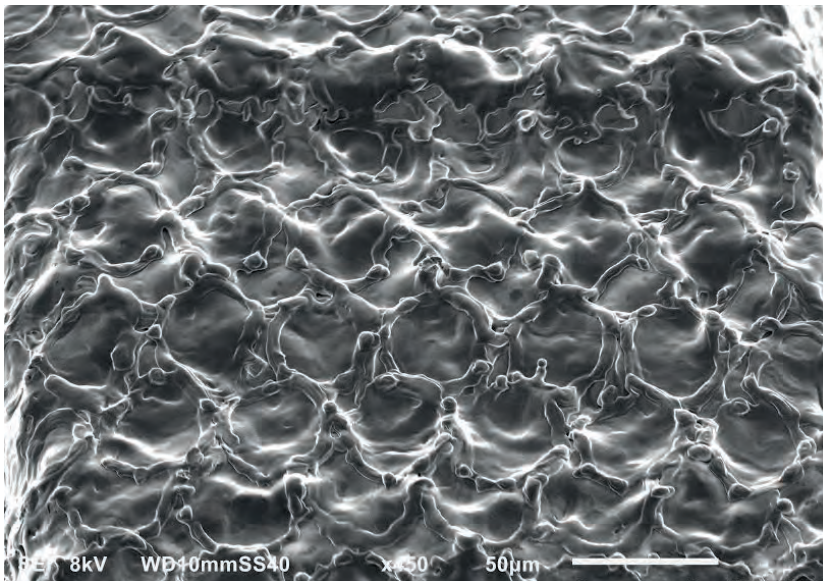

Rugosity (Ra)	Definition
$\leq 0,4 \mu\text{m}$	Smooth
0,5 - 1,0 μm	Machined
1,0 - 2,0 μm	Moderately rough
$> 2,0 \mu\text{m}$	Rough

Rugosity (Ra)	No-Itis® Laser
0,9 μm	Smooth

According to the classification of surface roughness by Albrektsson and Wenneberg, the Ra value corresponds to a moderately rough surface, and our lasered surface actually has the characteristics and many of the advantages of a smooth implant surface. The NO-ITIS® LASER surface allows the adhesion of the uniform and extended fibrin clot, which then leads to the formation of woven bone. The distribution and size of the concavities favours the accommodation and activity of the osteoblasts, promoting effective osseointegration

No-Itis® LASER
 THE MOST ADVANCED SURFACE A SAFE ANSWER
 AGAINST PERI-IMPLANTITIS, MAINTAINING THE
 OSSEOINTEGRATION LONG TERM

STABLE FIBRIN MESH

With the NO-ITIS® LASER, as with traditional rough surface, fibrin filaments are almost exclusively attached to surface peaks forming bridges between them (distance osteogenesis). On the NO-ITIS® LASER surface, fibrin forms as a well developed and defined grid mesh even within the concavities, which favours colonisation of the osteogenic cells directly on the surface of the implant (contact osteogenesis).

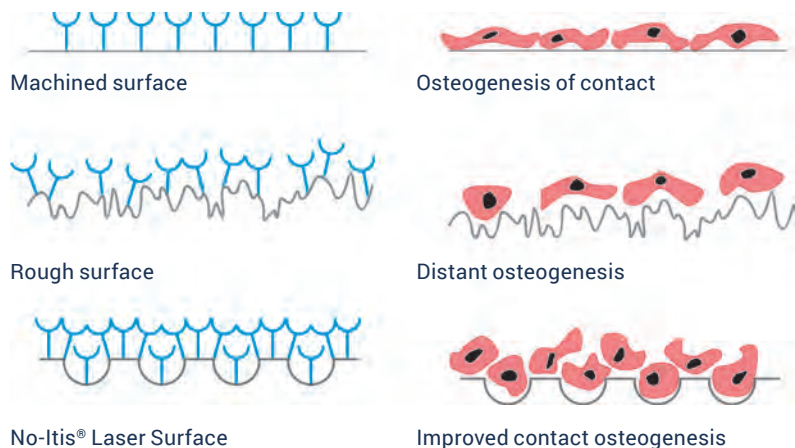

MAXIMUM CONTACT OSTEOGENESIS

Thanks to the good cell adhesion, a normal fibrin mesh can be created, adapted and extended on the surface of the NO-ITIS® LASER. This process activates the formation of osteonal bone, also directly in contact with the implant.

No-Itis® LASER
A UNIQUE SURFACE

No-Itis® LASER

THE IDEAL SURFACE FOR IMMEDIATE OR EARLY LOADING

The perfectly symmetrical and reproducible topography of the NO-ITIS® LASER surface attracts a greater number of osteogenic cells, allowing them to settle and to proliferate on the implant surface in a stable and uniform manner. This process activates the formation of bone directly in contact with the implant, resulting in a more dynamic and favourable osseointegration, with greater BIC (Bone implant Contact), and it allows true bone engineering.

RAPID OSSEOINTEGRATION

The perfectly symmetrical and reproducible topography of the NO-ITIS® LASER surface attracts a greater number of osteogenic cells, allowing them to settle and to proliferate on the implant surface in a stable and uniform manner.

- Smooth implant surface
- Less bacterial adhesion

➡ LOWER RISK OF INFECTIONS

- Increased fibrin adhesion
- More contact osteogenesis on a larger surface

➡ PERFECT OSSEOINTEGRATION

No-Itis® LASER – A CLEAN SURFACE

Unlike standard-surface implants (sandblasting and etching, or blasting and anodising), the implants with the NO-ITIS® LASER surface have a completely clean surface without residues nor contaminants. Due to this modern manufacturing process, no residues of jet particles or traces of the chemicals (acids) or anodisation (oxides) used in the etching process can come into contact with the implant. Eliminating the anodisation also eliminates the risk that the top layer of the coloured implant dissolves mechanically.

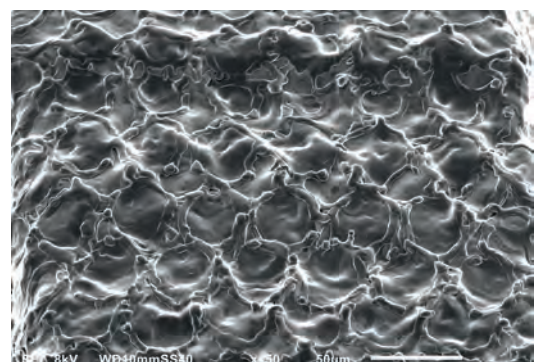

No-Itis® LASER A CLEAN SURFACE

No-Itis® LASER – THE IDEAL SURFACE FOR BONE CONTACT

The total cleanliness of the NO-ITIS® LASER allows the endosseous implant surface to be increased without having to accept the disadvantages of all the traditional methods for surface roughening.

This new surface generation can coexist for some time with others developed by onewaybiomed GmbH, while regularization of production and stocks, and therefore any reference may not be available on the new No-Itis® Laser surface.

PREPARATORY WORK FOR TEMPLATE APPLICATION

1. Ask your laboratory to prepare a drill template with the determined drillholes for the pilot drills. To be on the safe side, you can ask the laboratory to insert guide sleeves (REF BFH) into the drillholes, which specify the exact drill direction. Please use a 2.0 / 2.2 mm Ø drill for the pilot drilling.
2. For the following drill sequences you can use drill stops, which can be attached and tightened to the drill according to the length of drilling channel. Gingival thickness and template height are taken into account as needed. Thanks to the extremely high cutting efficiency of our drills, no ascending drilling sequences will usually be required.

Recommended RPM: 2000-5000. Apply sufficient cooling and allow the cooling to reach the working blades of the drills.

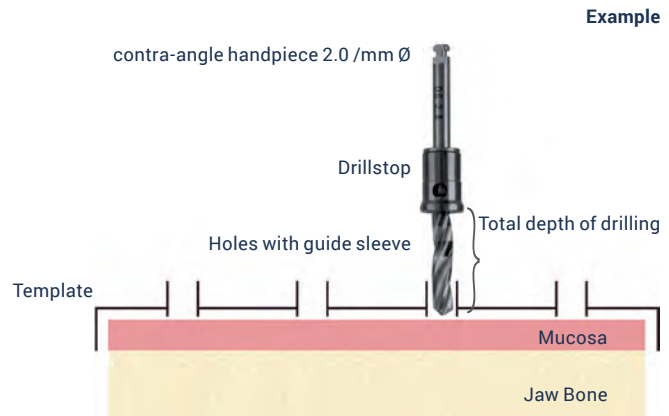

General note: GIH® implants are used as compression screws. In order to achieve a good bone condensation and implant stability, the drilling should be carried out thinner than the core diameter of the implant. The minimal diameter of the drill depends on the bone density. It is therefore not possible to advise drill-sequences which fit all bone-qualities. Typically in the soft maxillary bone only small drill-diameters are used (e.g. the usage of DOS1 only, for GIH® implants with 3.3 - 5.5 mm diameter), whereas in the highly mineralized lower jaw a specific drill sequence with respect to the mineralization of the bone is necessary. For insertion under pressure use the Handgrip. Due to technical reasons GIH® 2.9 mmd is not available with expanded apical thread. GIH2 implants with diameters 2.9 and 3.3 mm as well as 3.7 mm are not for use as single tooth restoration.

SURGERY

1. Recommended drill sequence

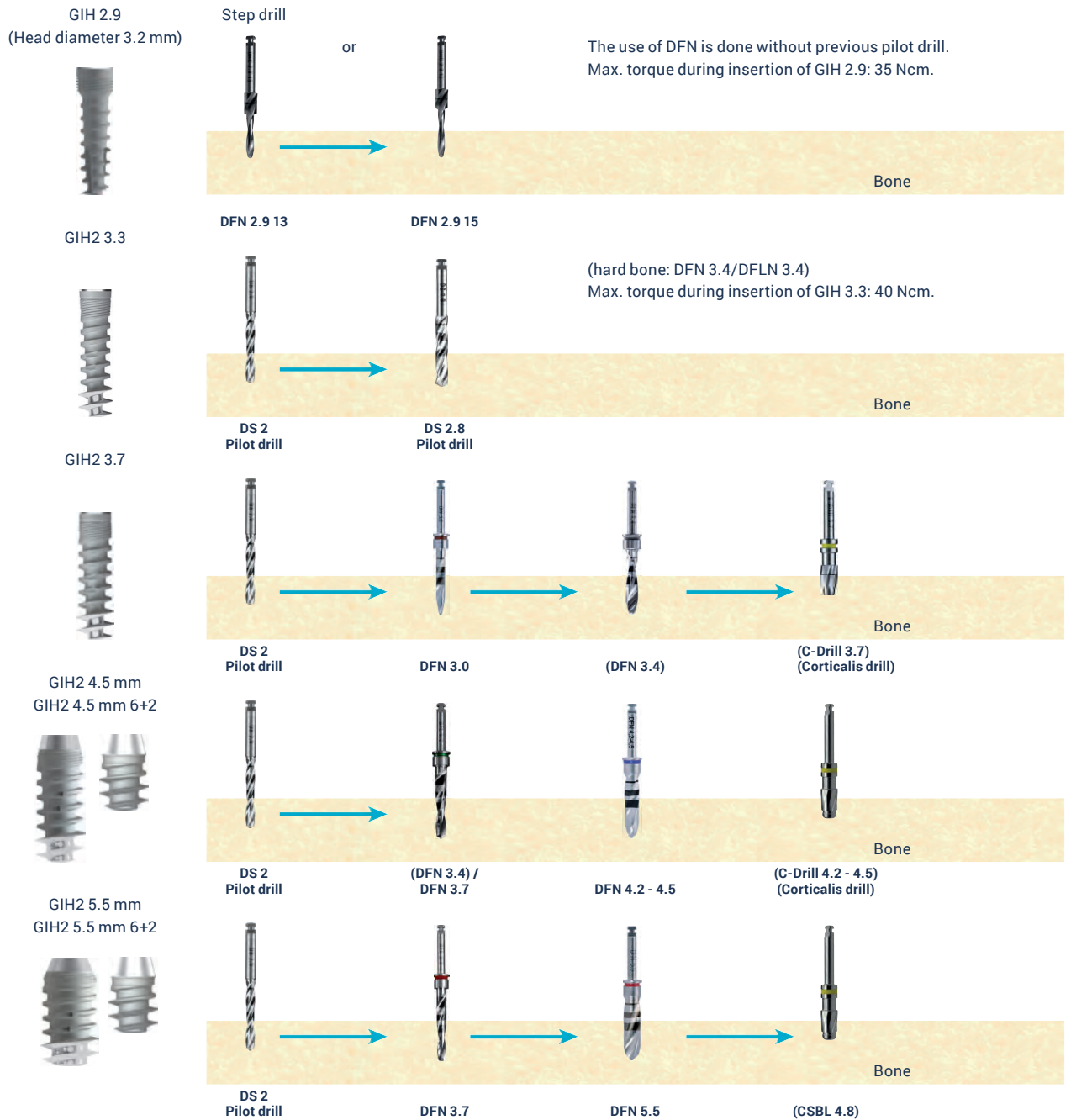

2. Implant packaging



Original packaging



Open the sealed cover at the lid. Remove the label and place it into the patients record.

3. Remove the implant from its packaging



The open pack contains the implant, mounted to a plastic holder.

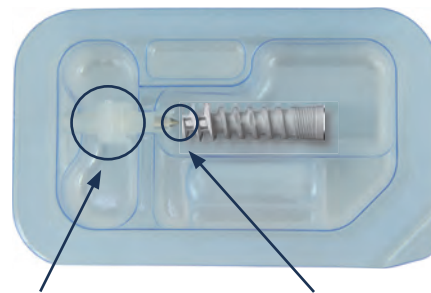

Remove the implant by holding onto the plastic holder

The implant is fixed to the holder by a break joint.

4. Handling

Attach the insertion tool to the implant by holding the top, to which the implant is secured, with your other hand.

Alternative: Firmly attach the assembled contra-angle hand-piece instrument IT 2.5 M to the implant. For ratchets ITL 2.5 can be used as well.

After you have attached the insertion tool, firmly hold the lid in your hand and break the implant off the top along the break joint. Then insert the implant into the drill hole as much as possible.

Insertion tool
IT 1 or IT 2
Make sure the hexagon is in the correct position and that the tool is fully inserted.
GIH® Implant
Break joint
Lid with implant mount

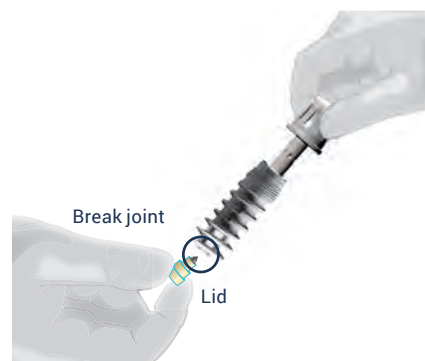

5. Insertion

Using the ratchet screw the implant clockwise into the cavity.

The endosseous part of the implant must be **completely** covered by the bone.

After insertion the implant can be turned by a ¼ rotation backwards in order to relieve the bone and allow blood access to the implant site.

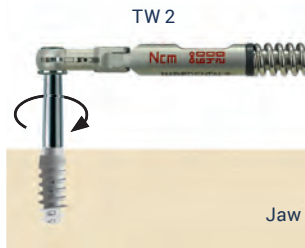

6. Remove insertion tool from implant

Remove the insertion tool from the implant.

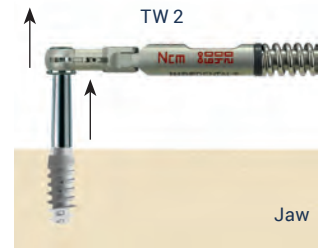

7. Result

Result: A correctly inserted implant



8. Post-operative treatment

Close the implant with the suitable surgical cover screw.

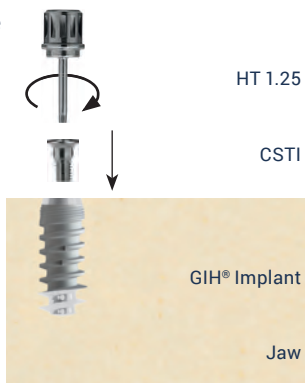

After healing: Remove the surgical cover screw.

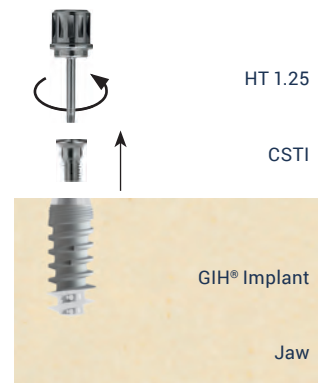

9. Handgrip

Use of Handgrip and GIH® adapter.



Break off the holder.

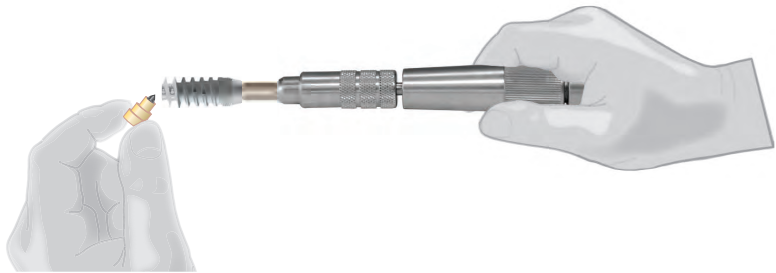

Insert the implant with axial pressure while turning.

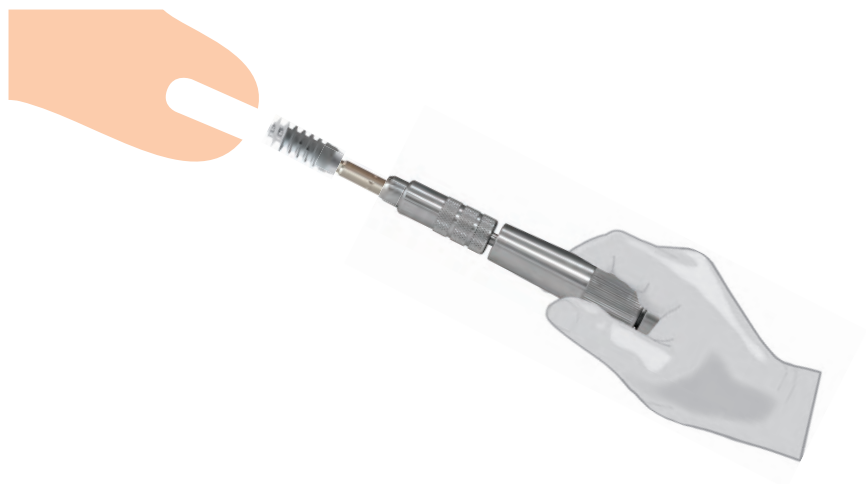

Max. insertion torque for diameter

2.9 mm	30 Ncm
3.3 mm	40 Ncm
3.7 mm	50 Ncm
4.5/5.5 mm	60 Ncm

10. Pick Up Impressions

Impression taking with an A-silicone such as Safeprint® by Dr. Ihde Dental. The use of open and closed impression tray is possible.

10.1 Pick-up-procedure with an individual impression tray.



10.2 Prior to the impression

For pick up impressions the tray is inserted over the impression post until the screw peaks out on the other side and becomes accessible for the HEX-tool.

The impression post HLT must not necessarily be unscrewed from the implant in order to remove the impression tray. It can be repositioned later as well

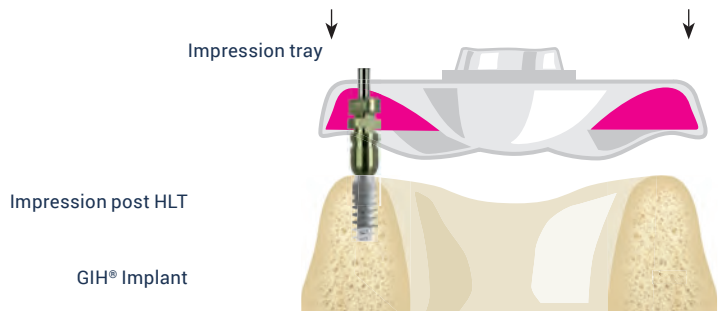

10.3 Taking the impression

Disengage HLT from the implant: HLT remains in the impression

After the impression is taken, the implant is closed with a healing abutment (Gingiva former - straight or anatomic) and the impression is sent to the laboratory.

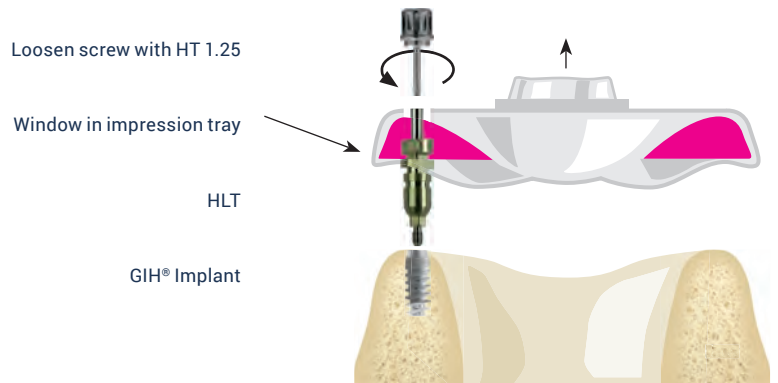

10.4 Preparation of the impression tray for model fabrication

Screw analog against the impression post.

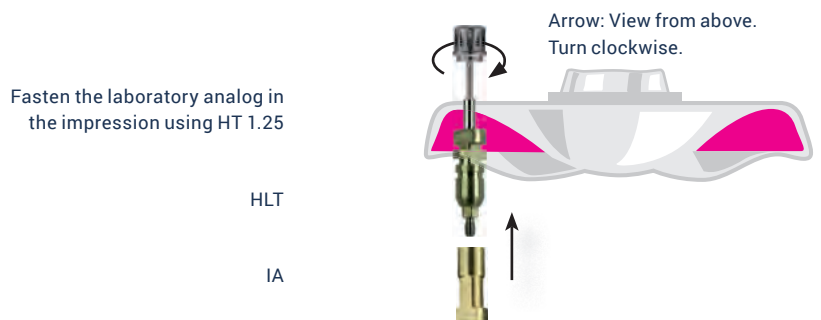

11. Closed tray impressions

11.1 Impression taking with a closed impression tray

To take impression use an adequately large impression tray.

Impression posts TS/TSL are mounted with the help of the knurled screw

Tighten the impression post with the knurled screw

TS/TSL HC

GIH® Implant

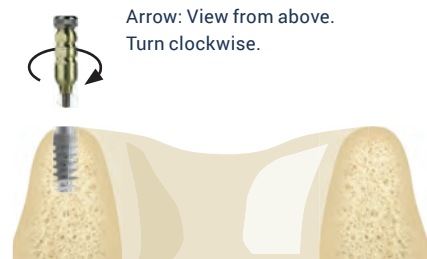

11.2 Inserting impression

The filled impression tray is positioned sufficiently deep over the impression post to also allow an impression of the mucosa.

Impression post
TS/TSL HC

GIH® Implant

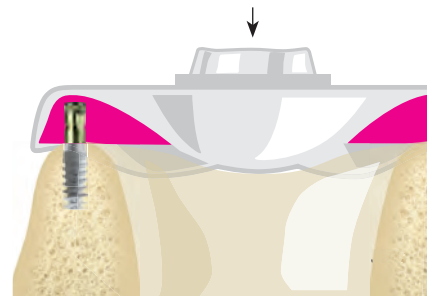

11.3 Removing impression

When the closed-tray method is applied, the impression post TS/TSL GIH remains on the implant after the impression tray is removed. After removal of the impression tray the impression post will be unscrewed and repositioned in the impression.

After the impression is taken, the implant is closed with a healing abutment (Gingiva former - straight or anatomic) and the impression is sent to the laboratory.

TS/TSL HC

GIH® Implant

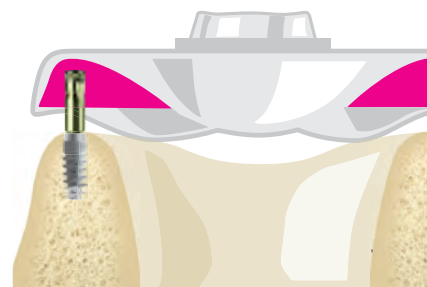

11.4 Mounting the lab analog

Screw analog IA or IA GIH M to the transfer post TS HC.

Afterwards the impression post is repositioned in the impression.

The impression can now be casted. In IA GIH M block the lower access to the lock screw out prior to casting.

Tighten the impression post onto the laboratory analog using the knurled screw

TS HC

IA or IA GIH M

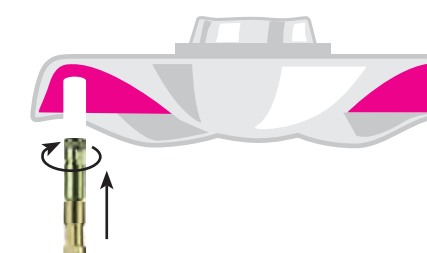

12. Laboratory procedures

12.1

The impression is poured. Then the impression posts (HLT or TS/TSL HC) are unscrewed from the laboratory analog.

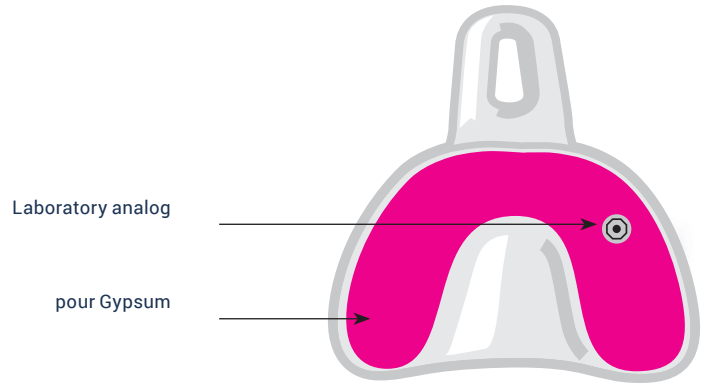

12.2

The laboratory analog is now in the proper position and orientation in the Gypsum.

IA or IA GIH M



12.3

Positioning of the screwable abutments TLA15 HC, thereby the optimal position and adequate angulation must be determined.

NOTE The hexagon must be completely inserted into the analog.

HT 1.25

Insert screw

TLA 15

Take care to position the hexagon correctly



Arrow: View from above.
Turn clockwise.

IA or IA GIH M



12.4

Ensure proper position of the abutment when transferring into the mouth.

Tightening torque of the screw during fastening on the implant: 20 Ncm

TLA 15 HC



12.5

If more than one angled abutment is used, your laboratory will prepare a detachable synthetic bar (e.g. from Pattern Resin) in order to facilitate the correct positioning in the mouth.

TLA 15 HC

Pattern Resin®

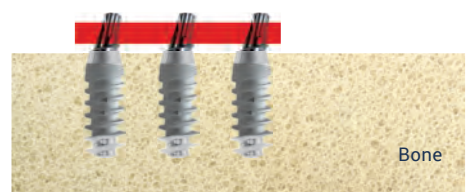



TWO PART
DENTAL IMPLANT SYSTEM GIH®

GIH2 IMPLANTS WITH AGGRESSIVE APICAL THREAD

GIH2 implants have a roughened endosseous surface and a machined apical thread. They feature an internal hex, an internal marginal taper and a US standard internal thread.

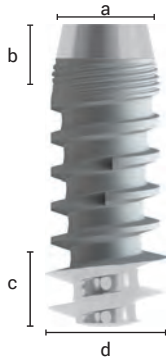

Dimensionen GIH2 4.5 13

- a) Nominal Ø 4.5 mm
- b) Length micro thread 2.5 mm
- c) Height of apical thread 3.2 mm
- d) Basal thread Ø 5.15 mm

GIH® WITH AGGRESSIVE APICAL THREAD: GIH2

As a result of many years of clinical observation of products, Dr. Ihde Dental AG has revised the design of the famous GIH® implant: the broadened apical thread is fully self-cutting. Thanks to the new apical thread portion, the implant is more stable even in weak bone and higher insertion torque can be reached.

If the implant is anchored in the 2nd cortical, it may be used in immediate load protocols. Especially in the upper jaw the usage of the new handgrip (REF BM1360, with Adapter IT GIH REF BM3168) for inserting the implant is mandatory. This tool allows to apply vertical insertion forces and will enhance the anchorage. The drill sequence remains unchanged compared to the former design of the GIH® implant. And of course all abutments and tools remain the same.

Should the first cortical be unusually firm, the insertion can be achieved using the handgrip REF311431 with the adapter IT GIH REF418196.

Application limitations

GIH® 2.9 mm implants may not be placed in a loaded area, especially not in the molar or premolar area. Likewise these implants may not be used where diagonal loading (off-axis loading) occurs, i.e. not for upper anteriors. Under no circumstances may GIH® 2.9 mm implants be used for work that involves unsupported occlusal surfaces (consoles). If used in immediate load protocols, the prosthetic construction must be safely inserted on the 2nd postoperative day, and it should not be removed within the first 6 months.

In general we recommend to use implants up to (and including) the diameter 3.7 mm with care and avoid using them for single tooth replacements, unless strict force control is guaranteed.

**GIH2 IMPLANTS
WITH AGGRESSIVE
APICAL THREAD**



Description	Enossal Ø	Enossal length	REF	Price cat.
GIH2 3.3 8	3.3 mm	8 mm	BM3270	G
GIH2 3.3 10	3.3 mm	10 mm	BM3271	G
GIH2 3.3 11.5	3.3 mm	11.5 mm	BM3272	G
GIH2 3.3 13	3.3 mm	13 mm	BM3273	G
GIH2 3.3 15	3.3 mm	15 mm	BM3274	G
GIH2 3.7 8	3.7 mm	8 mm	BM3275	G
GIH2 3.7 10	3.7 mm	10 mm	BM3276	G
GIH2 3.7 11.5	3.7 mm	11.5 mm	BM3277	G
GIH2 3.7 13	3.7 mm	13 mm	BM3278	G
GIH2 3.7 15	3.7 mm	15 mm	BM3279	G
GIH2 4.5 8	4.5 mm	8 mm	BM3280	G
GIH2 4.5 10	4.5 mm	10 mm	BM3281	G
GIH2 4.5 11.5	4.5 mm	11.5 mm	BM3282	G
GIH2 4.5 13	4.5 mm	13 mm	BM3283	G
GIH2 5.5 8	5.5 mm	8 mm	BM3284	G
GIH2 5.5 10	5.5 mm	10 mm	BM3285	G
GIH2 5.5 11.5	5.5 mm	11.5 mm	BM3286	G
GIH2 5.5 13	5.5 mm	13 mm	BM3287	G



Delivery inclusive surgical screw CSTI, REF BM3037

GIH® 6+2 IMPLANTS WITH AGGRESSIVE APICAL THREAD

GIH® 6+2 was especially developed for the area of the 1st and 2nd molars in the upper and lower jaw. It is possible and recommendable to use it as a compression screw implant in the upper jaw. Endosseous length 6-8 mm (8 mm incl. reverse cone). The upper edge of the polished 75° reverse cone can end at bone level or slightly above it. **GIH® 6+2** implants have a laser-generated surface structure (No-Itis® laser) in the enossal area.

The conical polished implant head (a) should be submerged into the bone.

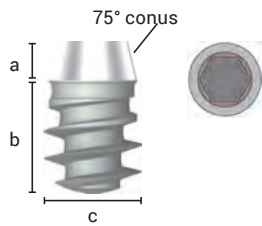
**Description**

GIH2 4.5 6+2

GIH2 5.5 6+2

Enossal Ø

4.5 mm

5.5 mm

Enossal length

6 mm

6 mm

REF**BM3288****BM3289****Price cat.****G****G**

a) Reverse conus	2 mm
b) Enossal length	6 mm
c) Enossal Ø	4.5 - 5.5 mm

Delivery inclusive surgical screw CSTI, REF BM3037



THE ADVANTAGES OF TRADITIONAL **GIH**[®] IMPLANTS

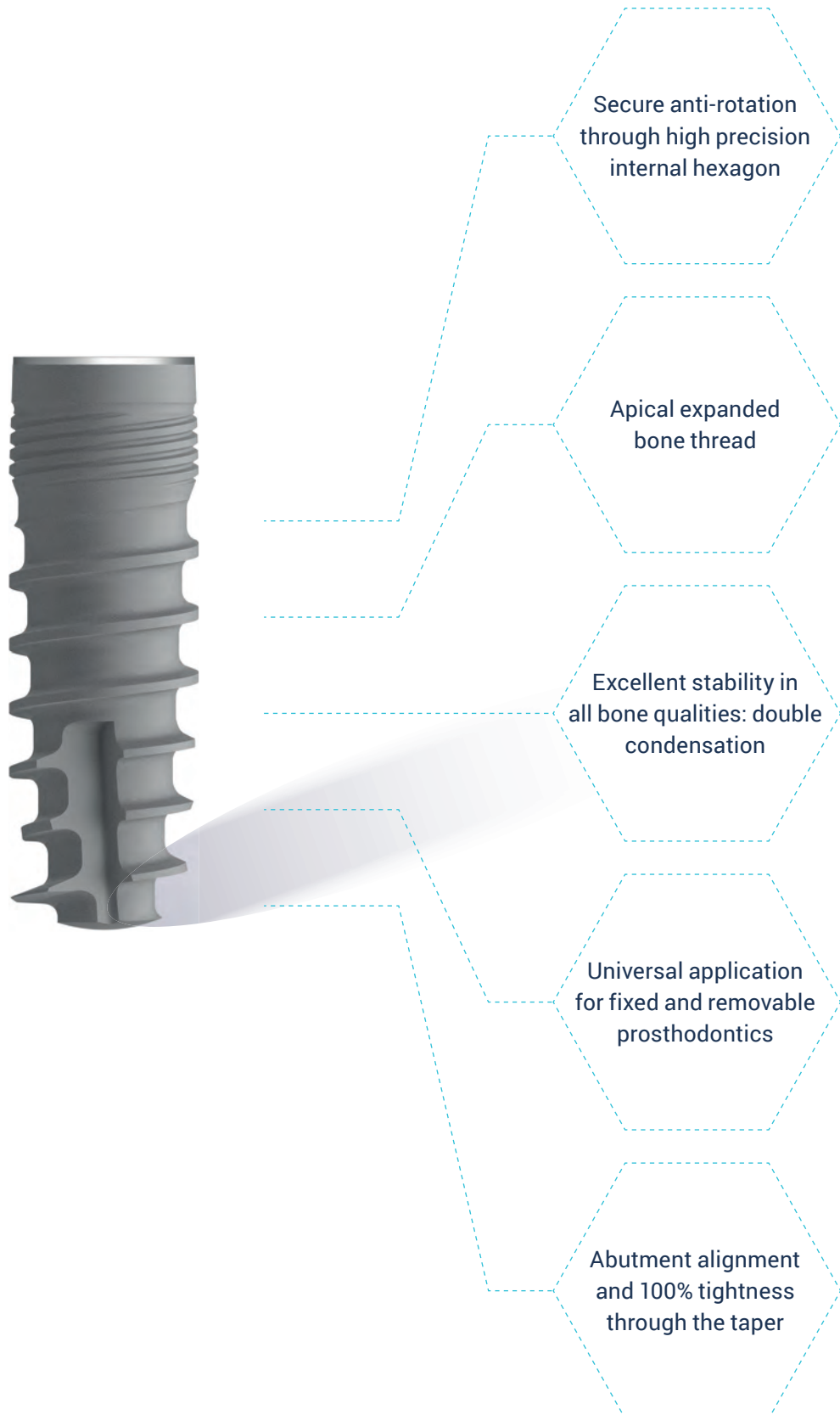

TRADITIONAL **GIH®** IMPLANTS

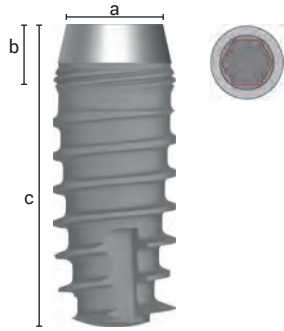

- a) Enossal Ø 2.9 - 5.5 mm
- b) Length micro thread and polished part 2.3 mm
- c) Enossal length 8 - 15 mm



Description	Enossal Ø	Enossal length	REF	Price cat.
GIH 2.9 13	2.9 mm	13 mm	BM3010	G
GIH 2.9 15	2.9 mm	15 mm	BM3011	G
GIH 3.3 8	3.3 mm	8 mm	BM3065	G
GIH 3.3 10	3.3 mm	10 mm	BM3066	G
GIH 3.3 11.5	3.3 mm	11.5 mm	BM3067	G
GIH 3.3 13	3.3 mm	13 mm	BM3068	G
GIH 3.3 15	3.3 mm	15 mm	BM3069	G
GIH 3.7 8	3.7 mm	8 mm	BM3012	G
GIH 3.7 10	3.7 mm	10 mm	BM3013	G
GIH 3.7 11.5	3.7 mm	11.5 mm	BM3020	G
GIH 3.7 13	3.7 mm	13 mm	BM3014	G
GIH 3.7 15	3.7 mm	15 mm	BM3015	G
GIH 4.1 8	4.1 mm	8 mm	BM3290	G
GIH 4.1 10	4.1 mm	10 mm	BM3291	G
GIH 4.1 11.5	4.1 mm	11.5 mm	BM3292	G
GIH 4.1 13	4.1 mm	13 mm	BM3293	G
GIH 4.5 8	4.5 mm	8 mm	BM3016	G
GIH 4.5 10	4.5 mm	10 mm	BM3017	G
GIH 4.5 11.5	4.5 mm	11.5 mm	BM3018	G
GIH 4.5 13	4.5 mm	13 mm	BM3019	G
GIH 5.5 8	5.5 mm	8 mm	BM3040	G
GIH 5.5 10	5.5 mm	10 mm	BM3041	G
GIH 5.5 11.5	5.5 mm	11.5 mm	BM3042	G
GIH 5.5 13	5.5 mm	13 mm	BM3043	G

Delivery inclusive surgical screw CSTI, REF BM3037



TRADITIONAL GIH® 6+2 IMPLANTS

GIH® 6+2 was especially developed for the area of the 1st and 2nd molars in the upper and lower jaw. It is possible and recommendable to use it as a compression screw implant in the upper jaw. Endosseous length 6-8 mm (8 mm incl. reverse cone). The upper edge of the polished 75° reverse cone can end at bone level or slightly above it. GIH® 6+2 implants have a laser-generated surface structure (No-Itis® laser) in the enossal area.

The conical polished implant head (a) should be submerged into the bone.

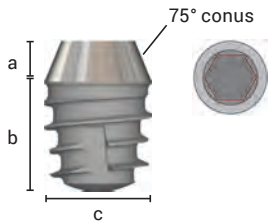

Description	Enossal Ø	Enossal length	REF	Price cat.
GIH 4.5 6+2	4.5 mm	6 mm	BM3055	G
GIH 5.5 6+2	5.5 mm	6 mm	BM3056	G

- a) Reverse conus 2 mm
- b) Enossal length 6 mm
- c) Enossal Ø 4.5 - 5.5 mm





Delivery inclusive surgical screw CSTI, REF BM3037

SURGICAL ACCESSORIES

Description	Code	REF	Price cat.
 Gingivaformer	for 3 mm gingival height HSI 3	BM3165	B
	for 5 mm gingival height HSI 5	BM3166	B
 Wide Gingivaformer	for 3 mm gingival height HSIW 3	BM3205	B
	for 5 mm gingival height HSIW 5	BM3206	B
 Anatomical Gingivaformer	3 mm high, 4.5 mm wide HSI 3-4.5	BM3180	B
	3 mm high, 5.5 mm wide HSI 3-5.5	BM3181	B
	5 mm high, 6.7 mm wide HSI 5-6.7	BM3182	B
 Gingivaformer	3 mm high, 3.3 mm wide HSIS 3-3.3	BM3190	B

Screwable abutments for cemented bridges, without anti-rotation protection. Trimming and grinding is possible. Tighten with HT 1.25. Recommended insertion torque **20 Ncm**.

	Description	Code	REF	Price cat.
	Height above implantat 8.5 mm The impression is made directly on the TCA, with tool TZ HC	TCA	BM3038	B
	The impression is made directly on the TCA W	TCA W	BM3191	B

Superstructure with hex and screw. Straight, for cemented bridges, without anti-rotation protection. Trimming and grinding is possible. Tighten with HT 1.25. Delivery inclusive screw SF 20. Recommended insertion torque **20 Ncm**.



	Description	Code	REF	Price cat.
	Abutment, height above implantat 8.5 mm	TLA HC	BM3030	D
	Abutment, narrow, for GIH 2.9	TLAS	BM3039	D
	Abutment with 2 mm gingival height	TLA GIH2	BM3045	D
	Abutment with 4 mm gingival height	TLA HC4	BM3046	D

	Description	Code	REF	Price cat.
	Abutment	TLA W	BM3210	D
	Anatomical abutment	ANAB	BM3189	E







	Description	Code	REF	Price cat.
	15°angled, 1 mm gingival height	TLA15 HC1	BM3031	F
	15°angled, 2 mm gingival height	TLA15 GIH2	BM3032	F
	15°angled, 3 mm gingival height	TLA15 HC3	BM3033	F
	25°angled, 1 mm gingival height	TLA25 HC1	BM3034	F
	25°angled, 2 mm gingival height	TLA25 GIH2	BM3035	F
	25°angled, 3 mm gingival height	TLA25 HC3	BM3036	F

Delivery inclusive screw SF 20



	Description	Code	REF	Price cat.
	Castable abutment for TLA GIH2/4	PA TLA HC	BM3110	A
	Castable abutment For TLA GIH and TCA	PA U	BM3204	A
	Transfer post For TLA GIH and TCA	TZ HC	BM3610	A

IMPRESSION TAKING AND LABORATORY ACCESSORIES

	Description	Code	REF	Price cat.
	Impression post Click-on No screw is needed	HLTC	BM3198	C
	Impression post For TLA, TLA 15 and TLA 25 For Pick-up, with screw	HLT	BM3107	C
	Pick-up screw For HLT REF 418108	SF HLT long	BM3129	B
	Impression post for HC Height 10.6 mm	TS HC	BM3106	C
	Impression post for HC Height 15.5 mm	TSL HC	BM3105	C
	Long impression post With screw	HLTS	BM3144	C
	Lab analogue For GIH®	IA HC	BM3103	B

DIGITAL IMPRESSION TAKING

	Description	Material	Unit	Code	REF	Price cat.
	Scanbody for digital impression taking Screw SF 20 is optional and must be ordered separately	POM	Pack of 5	Scanbody HC	BM1552	B

Screwable spacer abutment for bridges and bars. Tighten with **HT 1.77**. Recommended insertion torque **25 Ncm**.



Description

For gingival height 3 mm

Code

TSA 3

REF

BM3113

Price cat.

B

For gingival height 4 mm

TSA 4

BM3114

B

For gingival height 5 mm

TSA 5

BM3115

B

For gingival height 6 mm

TSA 6

BM3116

B



Description

Impression post

TSA analogue

Castable abutment
10.5 mm high
Pack of 5

Screw for fixation
PSS on BTS/TSA

Code

TS

BTS

PSS (white)

SF

REF

BM3117

BM3118

BM3119

BM3120

Price cat.

B

B

B

B

Screwable mesostructure for bridges and bars. Tighten with **HT 1.77**. Recommended insertion torque **25 Ncm**. The position of the TCT hex is assigned with this approach.



Description

For gingival height 0.5 mm

Code

TCT GIH 0.5

REF

BM3121

Price cat.

B

For gingival height 1.5 mm

TCT GIH 1.5

BM3122

B

For gingival height 2.5 mm

TCT GIH 2.5

BM3123

B



Description

Transfer post

Long screw

TCT analogue

Castable abutment
12 mm high
Internally round
Pack of 5

Castable abutment
12 mm high
Internally edged
Pack of 5

Screw for fixation

Code

TST

SFL

BTT

PSTR (grau)

PSTA

SF

REF

BM3124

BM3125

BM3126

BM3127

BM3128

BM3120

Price cat.

B

B

B

B

B

B

TCT SET

This set contains all necessary components for the mesiostructure. For bridges and bars. Screwable (anti-rotation).

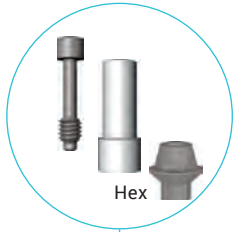

Description	Code	REF	Price cat.
Screw for PSTA	SF TCTL	BM3202	B
Castable abutment, 12 mm high Internally edged	PSTA	BM3128	B
Mesiostructure for bridges and bars, screwable	TCTL 0.5	BM3203	D
COMPLETE SET		BM3197	F



Description	Lab analogue For GIH®	Long transfer post For GIH and GIH2, with Hex	Short transfer post For GIH and GIH2, with Hex	Castable abutment, round, 12 mm high Pack of 5
Code	IA HC	HLTS	HLT	PSTR
REF	BM3103	BM3144	BM3107	BM3127
Price cat.	B	C	C	B

HEX REVERSE ABUTMENT

This abutment converts the internal hexagon of the GIH® implants into an external standard-hexagon. The prosthetic screw is screwed through. It tightens the prosthetic and the abutment at the same time.

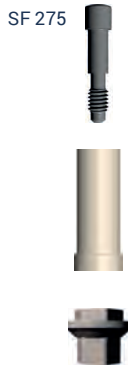

Description	Material	Code	REF	Price cat.
Tempbase for HRA HC	PEEK	TPB E	BM3187	C
Hex reverse abutment Incl. screw SF 275 REF 418275	Ti6Al4V	HRA HC	BM3186	D

LOCALICER®

We recommend a minimum of six implants per jaw and the use of a single denture as splint when using LOC abutments. Tighten with HT 1.77.



Description	Height	Code	REF	Price cat.
Localicer® for GIH®	2 mm	LOC GIH 2	BM3140	C
Localicer® for GIH®	4 mm	LOC GIH 4	BM3141	C

ACCESSORIES FOR LOCALICER®



Description	Code	REF	Price cat.
Analogue + impression set	AA LOC	BM3142	C



Description	Code	REF	Price cat.
Set with 5 caps + 1 housing (EXTERNAL PRODUCT)	NCS	BM3143	D

Pull-off force
 Yellow 600 g, Pink 1.200 g, Transparent 1.800 g, Violet 2.700 g
 Black has no retention and is designed for temporary solutions for up to one month

TITANIUM BASE FOR CAD CAM









Description	Type	Code	REF	Price cat.
Titanium base Incl. screw	Abutment base for zirkonium Anti-rotation Material Ti6Al4V	MB HC	BM3179	D

MULTI-UNIT ABUTMENTS

Insertion of the angled MU2 abutments with HT 1.25. Insertion of the straight MU2S abutments with HT 1.77. Not for use on single implant constructions.

	Description	Material	Code	REF	Price cat.
	Abutment 17° angled Incl. screw SF 20	Ti6Al4V	MU2 17 HC	BM2350	L
	Abutment 35° angled Incl. screw SF 20	Ti6Al4V	MU2 35 HC	BM2351	L
	Abutment straight Gingiva height 0.5 mm	Ti6Al4V	MU2S 0.5 HC	BM2352	G
	Abutment straight Gingiva height 1.5 mm	Ti6Al4V	MU2S 1.5 HC	BM2353	G
	Abutment straight Gingiva height 2.5 mm	Ti6Al4V	MU2S 2.5 HC	BM2354	G
	Gingivaformer incl. SF MU2 Height above abutment shoulder 6 mm	Ti6Al4V	GF MU 2	BM2362	C
	Localicer® incl. SF MU2 Height above abutment shoulder 6.7 mm Use with NCS Set REF 462338	Ti6Al4V	MU 2	BM2363	C
	Prosthetic screw for MU2 Extends into the implant	Ti6Al4V	SF 20	BM3228	B

ACCESSORIES FOR MULTI-UNIT ABUTMENTS

	Description	Material	Code	REF	Price cat.
	Temporary base SF MU2 sold separately	Ti6Al4V	TC MU2	BM2355	D
	Transfer straight incl. screw SFL MU2	Ti6Al4V	TS MU2	BM2356	C
	Castable for Multi-Unit incl. screw TC MU2 for UCLA on the MU2 abutment		PA MU2	BM2357	A
	Screw for TC MU2	Ti6Al4V	SF MU2	BM2358	B
	Lab analogue for Multi-Unit	Ti6Al4V	IA MU2	BM2360	B
	Hex instrument long		HT 1.25	BM3022	C
	Hex instrument for all superstructures		HT 1.77	BM3024	C

BALL ABUTMENT FOR REMOVABLE PROSTHETICS



Description

Ball abutment for fitting prostheses
Application on TSA 3-6 abutments only
Head diameter 2.5 mm

Code

SB

REF

BM3154

Price cat.

B



Description

Height above implantat
3-6 mm

Impression post
for TSA and TCA

TSA analogue

Code

TSA 3

TSA 4

TSA 5

TSA 6

TS

BTS

REF

BM3113

BM3114

BM3115

BM3116

BM3117

BM3118

Price cat.

B

B

B



Description

Gingiva height

Code

REF

Price cat.

0.5 mm

TB 0.5

BM3155

B

Ball abutment
Head diameter 2.5 mm
Tighten with HT 1.25
Use with NC caps

2 mm

TB 2

BM3156

B

4 mm

TB 4

BM3157

B

ACCESSORIES FOR BALLHEAD ABUTMENTS



Description

Nylon cap transparent, Pull-off force ca. 1200g
(EXTERNAL PRODUCT)

Unit

Pack of 2

Code

NC

REF

465028

Price cat.

A1



Nylon cap pink, Pull-off force ca. 800g
(EXTERNAL PRODUCT)

Pack of 2

NC 1

465029

A1



Nylon cap yellow, Pull-off force ca. 500g
(EXTERNAL PRODUCT)

Pack of 2

NC 2

465030

A1



Green, strong Nylon caps R-NC
With increased friction strength
Only with reduced diameter ball
≤ 2.3 mm

Pack of 2

R-NC

465034

A1



Pink, medium (EXTERNAL PRODUCT)

Pack of 2

R-NC 1

465033

A1



Orange, soft (EXTERNAL PRODUCT)

Pack of 2

R-NC 2

465032

A1







Metal sleeve for all nylon caps
(EXTERNAL PRODUCT)

H

465031

B

INSERTION TOOLS

	Description	Type	Code	REF	Price cat.
	IT 2.5	8 mm, click-on, hexagon	IT 2.5	BM3161	B
	ITL 2.5	22 mm, click-on, hexagon	ITL 2.5	BM3162	B
	ITM 2.5	20 mm, click-on, hexagon	ITM 2.5	BM3212	B
	IT 2.5 M	Insertion tool For contra-angle	IT 2.5 M	BM3164	B
	ITWH 2.5 M	Insertion tool with hex For W&H contra-angle	ITWH 2.5 M	BM3167	C

INSTRUMENTS AND TOOLS

	Description	Type	Code	REF	Price cat.
	Hex instrument 1.25	21 mm	HT 1.25	BM3022	C
	Hex instrument 1.25	For contra-angle, 45 mm	HTW 1.25	BM7701	C
	Hex instrument 1.25	14 mm	HTS 1.25	BM3023	C
	Hex instrument 1.77	For all superstructures, 19 mm	HT 1.77	BM3024	C
	Hex instrument 1.25 M	For contra-angle, 26.1 mm	HT 1.25 M	BM3047	C
	Hex instrument 1.77 M	For contra-angle, 28.6 mm	HT 1.77 M	BM3048	C
	Hex instrument	45 mm, 1.25 Ø	HTX 1.25	BM7764	C
	Hex instrument	45 mm, 1.77 Ø	HTX 1.77	BM1070	C
	Punch	For contra-angle, 4.9 mm Ø	PUW1	BM3002	C
	Punch	Manual, 5.2 mm Ø	PU	BM3004	C
	Standardized probe	Scale 1 mm for X-ray measurements 22 mm	PDG	BM1350	A
	Drill extension contra-angle	Extends by 19 mm	DX2	BM1349	D
	Guide sleeve	For pilot drill, Titan, 10 mm, 2.2 mm Ø Pack of 5	BFH	BM6537	B
	X-ray measuring sphere	Surgical steel, 0.5 mm Ø Pack of 5	RM	BM3006	A

GUIDE JACKET



Description
BFH 2.0 guide jacket 2.0 mmd

Unit Pack of 5
Material Ti6Al4V
REF **BM7100**
Price cat. **B**



BFH 2.5 guide jacket 2.5 mmd

Pack of 5 Ti6Al4V **BM7101** **B**



BFH 3.0 guide jacket 3.0 mmd

Pack of 5 Ti6Al4V **BM7102** **B**



BFH 3.2 guide jacket 3.2 mmd

Pack of 5 Ti6Al4V **BM7103** **B**



BFH 3.5 guide jacket 3.5 mmd

Pack of 5 Ti6Al4V **BM7104** **B**

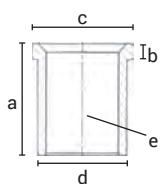

- a) Length 5 mm
- b) Height of step 0.7 mm
- c) Max. Ø top 3.7 - 5 mm
- d) Nominal Ø 3 - 4.4 mm
- e) Ø of drilling in the drill template 2.05 - 3.55 mm



Model with residual teeth for the fabrication of a drill guide for creating cavities for fixing the later drill guide for implant cavities.



Drill guide for creating cavities for later fixation of the surgical drill guide.



Surgical drill guide for safe BCS® placement. The drill sleeves are designed for 2.0 mm Twist drills.

HANDGRIP TRAY**Description**

Adapter

TypeFor all contra-angle instruments
For handgrip**Code****Adapter Wst****REF****BM5116****Price cat.****C**

Adapter for handgrip

Adapter IT HC**BM3168****C**

Handgrip

For machine reprocessing, cannot
be dismantled
Clean in an ultrasonic bath at 45°
with an alkaline cleaning agent
For adapter, self-locking**Handgrip****BM1360****V**

To clean this tool a heatable ultrasonic bath and a thermo disinfector (i.e. Miele TD-Serie) are required.

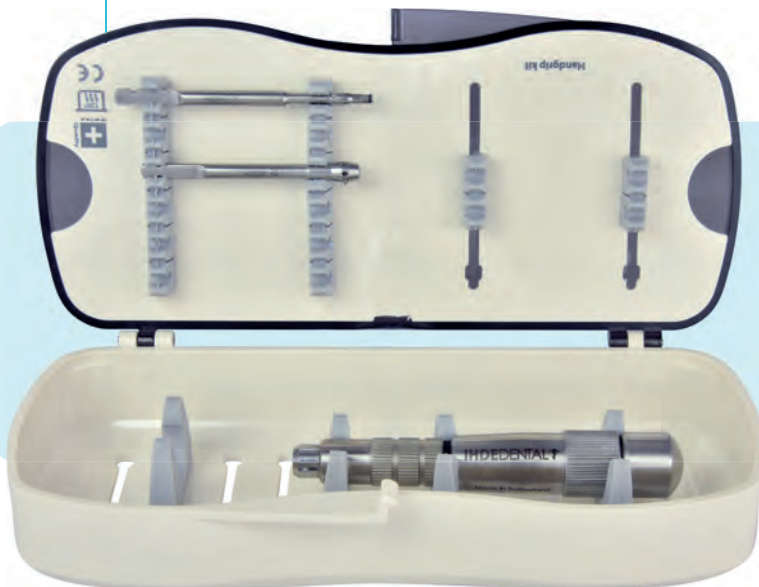
**HANDGRIP TRAY w/o content**

Size of closed tray:

W 195 mm D 90 mm H 45 mm**REF BM2061****Price cat. K**For safe storage and sterilization of
handgrips (max. 3 pieces) and adapters
(max. 8 pieces). Plastic, autoclaveable
up to 134° C, not suitable for dry heat
sterilizers.







HEATLESS® DRILLS FOR IMPLANTS WITH CONICAL CORE

Surgical steel, color-coded, depth-coded and autoclaveable. The drill is marked with laser depth markings.

Use between 3,000 and 5,000 rpm with good cooling and intermittent drill technique.

Due to the extremely high cutting performance, you can work without pressure.

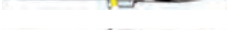
For the implant systems GIH® and Xign®. Drill types DFN 3.0 - DFN 4.2-4.5.

	Ø working range	Max. working depth	Total length	Colour	Code	REF	Price cat.
	0.1 - 1.5 mm	15 mm	31.7 mm	yellow	BCD 1	BM2100	C
	0.1 - 1.5 mm	15 mm	42 mm	yellow	BCDX 1	BM2103	C
	2.0 / 3.6 mm	13 mm	30 mm	-	DFN 2.9 13	BM2324	E
	2.0 / 3.6 mm	15 mm	32 mm	-	DFN 2.9 15	BM2325	E
	2.0 mm	17 mm	32.5 mm	-	DS 2	BM1359	D
	2.8 mm	17 mm	36.5 mm	-	DS 2.8	BM1404	D
	2.8 mm	25 mm	44.5 mm	-	DSL+ 2.8	BM1407	E
	2.7 mm	18 mm	36 mm	brown	DFN 3.0	BM2326	E
	3.0 mm	18 mm	36 mm	grey	DFN 3.4	BM2327	E
	3.4 mm	18 mm	36 mm	yellow	DFN 3.7	BM2328	E
	3.5 mm	18 mm	36 mm	green	DFN 4.1	BM4203	E
	4.05 mm	18 mm	36 mm	blue	DFN 4.2 - 4.5	BM2329	E
	4.4 mm	18 mm	36 mm	red	DFN 5.5	BM2330	E
	2.7 mm	18 mm	39 mm	brown	DFLN 3.0	BM2331	E
	3.0 mm	18 mm	39 mm	grey	DFLN 3.4	BM2332	E
	3.4 mm	18 mm	39 mm	yellow	DFLN 3.7	BM2333	E
	4.05 mm	18 mm	39 mm	blue	DFLN 4.2 - 4.5	BM2334	E
	3 mm	25 mm	43.5 mm	grey	DFLN+ 3.4	BM2321	E
	3.4 mm	11.5 mm	30 mm	yellow	DFSN 3.7	BM2322	D
	3.9 mm	11.5 mm	30 mm	blue	DFSN 4.2 - 4.5	BM2323	D
	max. 3.8 mm	max. 5 mm	27 mm	yellow	C Drill 3.7	BM2338	D
	max. 4.1 mm	2.5 mm	27 mm	green	C Drill 4.1	BM4204	D
	max. 4.6 mm	max. 5 mm	27 mm	blue	C Drill 4.2 - 4.5	BM2340	D
	max. 5.5 mm	2.5 mm	27 mm	red	C Drill 5.5	BM2346	D

IT HAS BEEN SCIENTIFICALLY PROVEN

that Dr. Ihde Dental Heatless® Drills generate 55 % less heat compared to traditional bone drills by other manufacturers. This enables higher rotational speeds: We recommend between 3.000 and 5.000 RPM with good external cooling and intermittent drill technique.

INSTRUMENT TRAY

Autoclaveable up to 134° C. Not suitable for dry heat sterilizers. Size of closed tray: W 175 mm D 145 mm H 65 mm



Description	Code	REF	Description	Code	REF	Price €
Twist drill	BCD 1	BM2100	Insertion tool short	IT 2.5	BM3162	
Twist drill	DS 2	BM1359	Insertion tool medium	IT 2.5 M	BM3164	
Twist drill	DS 2.8	BM1404	Universal adapter	UAW	BM3026	
Form drill	DFN 2.9 13	BM2324	Hex instrument 1.25 long	HT 1.25	BM3022	
Form drill	DFN 2.9 15	BM2325	Hex instrument 1.25 short	HTS 1.25	BM3023	
Form drill	DFN 3.0	BM2326	Hex instrument 1.77	HT 1.77	BM3024	
Form drill	DFN 3.7	BM2328	Punch	PUW 1	BM3002	
Form drill	DFN 4.2 - 4.5	BM2329	Drill extension	DX 2	BM1349	
Form drill	DFN 5.5	BM2330	Standardized probe	PDG	BM1350	
Form drill	DFSN 3.7	BM2322	Standardized probe	PDG	BM1350	
Form drill	DFSN 4.2 - 4.5	BM2323	Standardized probe	PDG	BM1350	
Cortical drill	C Drill 3.7	BM2338	Twist drill	DFLN 3.0	BM2331	
Cortical drill	C Drill 4.2 - 4.5	BM2340	Twist drill	DFLN 3.7	BM2333	
Cortical drill	C Drill 5.5	BM2346	Twist drill	DFLN 4.2 - 4.5	BM2334	
Insertion tool long	ITL 2.5	BM3162	Torque wrench	TW2	BM1356	
			Tray with content		BM3209	upon request
			Tray w/o content		BM4265	upon request

Please read our detailed instructions for cleaning and re-sterilization of surgical instruments on implant.com/en/downloads

DRILLSTOP TRAY

Not suitable for dry heat sterilizers.



Description	Code	REF	Price €
Drillstop A		BM1500	
Drillstop C		BM1502	
Drillstop D		BM1503	
Drillstop E		BM1504	
Drillstop G		BM1506	
Drillstop I		BM1508	
Drillstop J		BM1509	
Drillstop K		BM1510	
Drillstop L		BM1511	
Form drill	DFN 3.0	BM2326	
Form drill	DFN 3.4	BM2327	
Form drill	DFN 3.7	BM2328	
Form drill	DFN 4.1	BM4203	
Form drill	DFN 4.2 - 4.5	BM2329	
Form drill	DFN 5.5	BM2330	
Form drill	DFLN 3.0	BM2331	
Form drill	DFLN 3.4	BM2332	
Form drill	DFLN 3.7	BM2333	
Form drill	DFLN 4.2 - 4.5	BM2334	
Tray with content		BM6676	739.00

STARTER tray

This surgical kit contains all drills and tools for first works with the GIH® system. Material: Plastic. Autoclaveable up to 134° C. Not suitable for dry heat sterilizers.



Description	Code	REF	Price €
Insertion tool	IT 2.5	BM3161	
Insertion tool	ITL 2.5	BM3162	
Insertion tool	ITM 2.5	BM3212	
Hex instrument long	HT 1.25	BM3022	
Twist drill	DS 2.0	BM1359	
Twist drill	DS 2.8	BM1404	
Form drill	DFN 3.0	BM2326	
Form drill	DFN 3.4	BM2327	
Form drill	DFN 3.7	BM2328	
Form drill	DFN 4.1	BM4203	
Form drill	DFN 4.2-4.5	BM2329	
Corticalis drill 3.7	C-Drill 3.7	BM2338	
Corticalis drill 4.1	C-Drill 4.1	BM4204	
Corticalis drill 4.2 - 4.5	C-Drill 4.2 - 4.5	BM2340	
Torque wrench	TW2	BM1356	
Starter tray for GIH® with content		BM6506	upon request
Starter tray for GIH® w/o content		BM3007	upon request

THE ADVANTAGES OF GIH® PLUS MU 0° AND 15° IMPLANTS

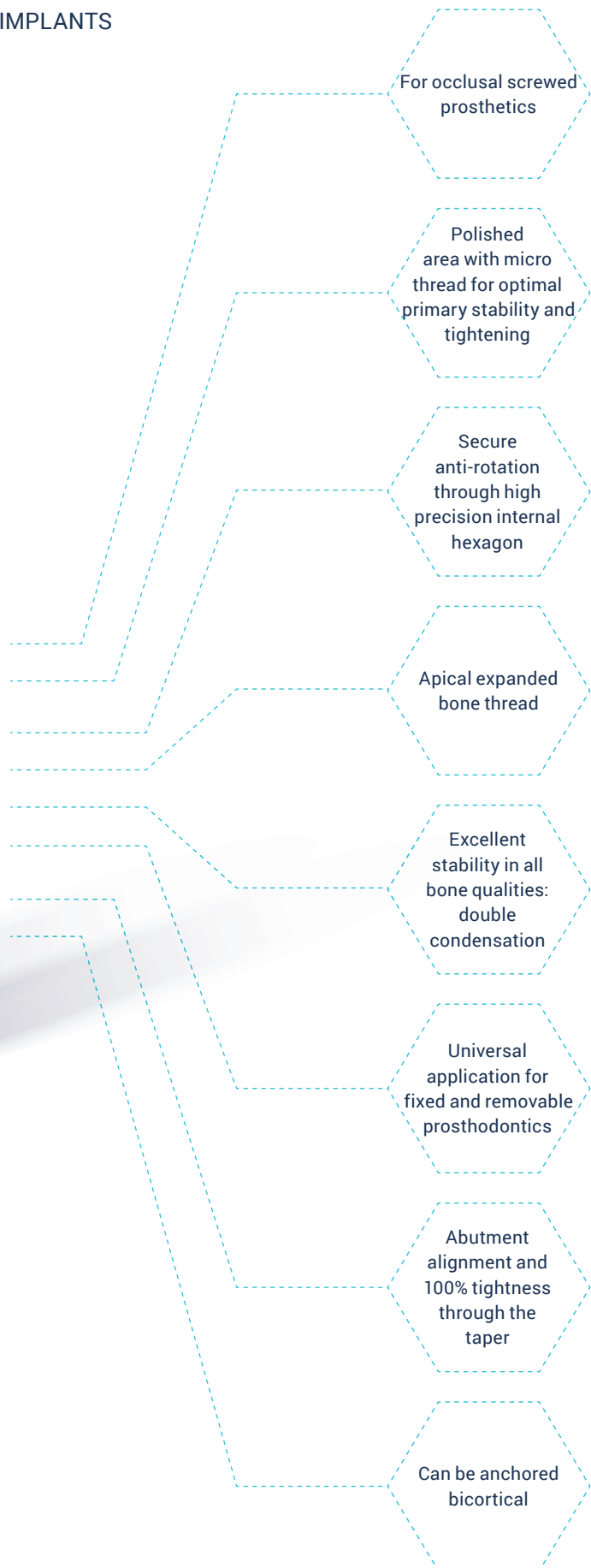

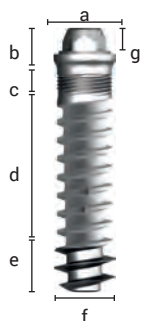
GIH® PLUS MU 0° IMPLANTS

a) Platform Ø	4.8 mm
b) Head height	2.6 mm
c) Length micro thread	1.5 mm
d) Enossal length	11.5 - 21.5 mm
e) Height apical thread	3.2 mm
f) Max. enossal Ø	3.3 / 4.1 mm
g) Connecting part	2 mm

Max. insertion torque 35 Ncm Material Ti6Al4V



Description	Max. nominal Ø / without apical thread	Max. nominal Ø / with apical thread	Enossal length	REF	Price cat.
GIH Plus MU 3.3 13 0°	3.3 mm	4 mm	13 mm	BM8250	G
GIH Plus MU 3.3 15 0°	3.3 mm	4 mm	15 mm	BM8251	G
GIH Plus MU 3.3 17 0°	3.3 mm	4 mm	17 mm	BM8252	G
GIH Plus MU 3.3 19 0°	3.3 mm	4 mm	19 mm	BM8253	G
GIH Plus MU 3.3 21 0°	3.3 mm	4 mm	21 mm	BM8254	G
GIH Plus MU 3.3 23 0°	3.3 mm	4 mm	23 mm	BM8255	G
GIH Plus MU 4.1 10 0°	4.1 mm	4.7 mm	10 mm	BM8259	G
GIH Plus MU 4.1 13 0°	4.1 mm	4.7 mm	13 mm	BM8260	G
GIH Plus MU 4.1 15 0°	4.1 mm	4.7 mm	15 mm	BM8261	G
GIH Plus MU 4.1 17 0°	4.1 mm	4.7 mm	17 mm	BM8262	G
GIH Plus MU 4.1 19 0°	4.1 mm	4.7 mm	19 mm	BM8263	G
GIH Plus MU 4.1 21 0°	4.1 mm	4.7 mm	21 mm	BM8264	G
GIH Plus MU 4.1 23 0°	4.1 mm	4.7 mm	23 mm	BM8265	G

Description	Code	REF	Price cat.
Insertion tool incl. screw REF 418316. For Hexacone Plus MU.	IT HCMU	BM3302	F

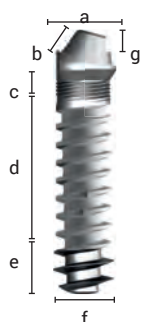
**GIH® PLUS MU 15° IMPLANTS**

a) Platform Ø	4.8 mm
b) Head height	3.9 mm
c) Length micro thread	1.5 mm
d) Enossal length	11.5 - 21.5 mm
e) Height apical thread	3.2 mm
f) Max. enossal Ø	3.3 / 4.1 mm
g) Connecting part	2 mm













Max. insertion torque 35 Ncm Material Ti6Al4V





Description	Max. nominal Ø / without apical thread	Max. nominal Ø / with apical thread	Enossal length	REF	Price cat.
GIH Plus MU 3.3 13 15°	3.3 mm	4 mm	13 mm	BM3070	G
GIH Plus MU 3.3 15 15°	3.3 mm	4 mm	15 mm	BM3071	G
GIH Plus MU 3.3 17 15°	3.3 mm	4 mm	17 mm	BM3072	G
GIH Plus MU 3.3 19 15°	3.3 mm	4 mm	19 mm	BM3073	G
GIH Plus MU 3.3 21 15°	3.3 mm	4 mm	21 mm	BM3095	G
GIH Plus MU 3.3 23 15°	3.3 mm	4 mm	23 mm	BM3096	G
GIH Plus MU 4.1 10 15°	4.1 mm	4.7 mm	10 mm	BM3076	G
GIH Plus MU 4.1 13 15°	4.1 mm	4.7 mm	13 mm	BM3077	G
GIH Plus MU 4.1 15 15°	4.1 mm	4.7 mm	15 mm	BM3078	G
GIH Plus MU 4.1 17 15°	4.1 mm	4.7 mm	17 mm	BM3079	G
GIH Plus MU 4.1 19 15°	4.1 mm	4.7 mm	19 mm	BM3080	G
GIH Plus MU 4.1 21 15°	4.1 mm	4.7 mm	21 mm	BM3081	G
GIH Plus MU 4.1 23 15°	4.1 mm	4.7 mm	23 mm	BM3082	G

Description	Code	REF	Price cat.
Insertion tool for KOS MU, BCS MU and Hexacone Plus MU 15°. Use with IT2 BCS, IT2 S BCS, AH-MU, for handgrip. Tool for screw: HT 1.25.	ITX MU15	BM3222	G





ACCESSORIES

	Description	Code	REF	Price cat.
	Insertion tool for GIH® Plus MU 0°	IT HCMU	BM3302	F
	Insertion tool for GIH® Plus MU 15° Use with IT2 BCS, IT2 S BCS, AH-MU	ITX MU15	BM3222	G
	Hex instrument 1.25, length 21 mm For fixation of Insertion tool ITX MU 15	HT 1.25	BM3022	C
	Adapter for handgrip For ITX MU15 (REF BM3222)	AH-MU	BM2068	F
	Castable abutment Use with T-Base and SF K MU	PA2 MU	BM3170	B
	Lab analogue For MU implants	IA K MU	BM3178	B
	Prosthetic screw	SF K MU	BM3159	B
	Transfer for Pick-Up Straight Delivery incl. SFL MU	HLT MU	BM3152	C
	Long screw for prosthetic use or as pick-up Tool: HT 1.25 Material Ti6Al4V	SFL MU	BM3218	B
	Castable abutment UCLA For direct use on MU implants SF K MU sold separately	PA MU	BM3200	B
	Transfer Coping (Temporary base) SF K MU sold separately	TC MU	BM3151	D
	Scan abutment for MU implants Incl. screw SSA MU. Sterilisable, two-part Material Ti6Al4V	SAB MU	BM3135	D

ACCESSORIES FOR HEXACONE® PLUS MU

	Description	Code	REF	Price cat.
	Ratchet for all Hex instruments and insertion tools	RAT 2	BM1352	K
	Torque wrench 10 - 70 Ncm. It is recommended to have the torque ratchets recalibrated by us once a year.	TW2	BM1356	S

SCANBODIES

	Description	Systems	Material	Unit	Code	REF	Price cat.
 Top view 	Scanbody-MU cylindrical	GBC® MU GCS® MU GIH® MU	POM	Pack of 5	Scanbody-MU	BM1563	B
 Top view 	Flag-Scanbody SCB MU incl. screw SFK MU (REF 418164) For intra-oral scans	GBC® MU GCS® MU GIH® MU	POM	Pack of 1	SCB MU	BM5128	B

Please go to <http://simpladent-implant.com/en/stl> to download the corresponding STL files.

ONEWAY BIOMEED

Due to technical reasons the product dimensions shown in this brochure might deviate from reality.
GIH® is a registered trademark.
GIH® implants are patent-protected.
 In case that implants would be reprocessed (cleaned, resterilized) infections could occur, because no validated procedures for reprocessing are available.

(The products of this catalogue are CE marked (class I) and CE 1936 marked (class IIa and IIb) according to 93/42/EC Directive).

Commercial products that are not monitored by our notified body are declared as third-party products.

Compilation and explanation of symbols on the packaging:



Batch No.



Sterilized by gamma radiation



Non-sterile



Intended for use by dentists or surgeons only



Single use product



Instruction for use



Expiry date



Store in a dry place



Store tightly keep closed



Do not use if packing is damaged



Do not resterilize



Manufacturer



Production date



Catalogue number



Secure anti-rotation through high precision internal hexagon

Apical expanded bone thread

Excellent stability in all bone qualities: double condensation

Universal application for fixed and removable prosthodontics

Abutment alignment and 100% tightness through the taper

ONEWAY
BIOMEED



Dr. Ihde **Dental AG**
Dorfplatz 11
CH - 8737 Gommiswald / SG
Tel +41 (0)55 293 23 23
contact@implant.com
www.implant.com

Distributed by **onewaybiomed GmbH**
Dorfplatz 11
CH - 8737 Gommiswald / SG
Phone +41 (0)55 293 23 23
Fax +41 (0)55 293 23 00
contact@implant.com
www.onewaybiomed.com



Dr. Ihde Dental GmbH
Erfurter Str. 19
D - 85386 Eching / München
Tel +49 (0)89 319 761 0
info@ihde-dental.de